

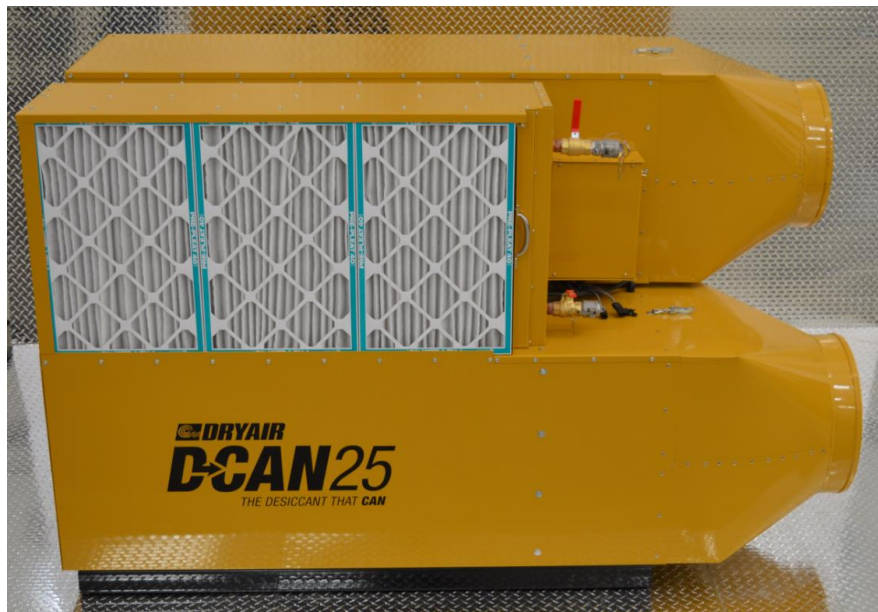

## Operator Manual

**DCAN25**  
**DCAN30**



S.N. 1684-01 -

**DRYAIR Manufacturing Corp.**  
**400 Service Road, PO Box 126**  
**St. Brieux, SK, Canada**  
**S0K 3V0**

**Tel: (306) 275-4848 1-888-750-1700**

**Fax: (306) 275-4664**





## Table of Contents

1. Warranty Policies & Claim Procedures .....	1-1
Warranty Policies.....	1-1
Basic Warranty Policy .....	1-1
Extended Warranty Policy .....	1-1
Exceptions to the Warranty Policies .....	1-1
Owner Obligations .....	1-2
Manufacturer Obligations .....	1-2
Warranty Claim Procedure .....	1-3
2. Safety Concerns .....	2-1
General Safety Concerns .....	2-1
Heating Appliance .....	2-1
Heat Transfer Fluid .....	2-1
3. Introduction .....	3-1
Electrical Connections.....	3-2
Fluid Connections.....	3-2
4. Setup .....	4-1
Positioning.....	4-1
5. Operation .....	5-1
6. Troubleshooting.....	6-1
Fan Does Not Start .....	6-1
No Power .....	6-1
Fans Running and No Heat .....	6-1
Fluid Inlet is Cold .....	6-1
Fluid Inlet is Hot, the Outlet is Cold and Still No Heat .....	6-1
Heat Transfer Fluid is Leaking.....	6-1
7. Maintenance.....	7-1
Daily Checklist.....	7-1
Check the Heat Coil for Cleanliness or Clogging.....	7-1
Check all Fluid Fittings and Connections Daily .....	7-1
Check the Air Filter Daily if Applicable (Air Filter Not Supplied By DRYAIR).....	7-1
Storage.....	7-1
Hardware.....	7-1
Hose & Plastics .....	7-1
8. Appendix .....	8-1
Electrical Schematic .....	8-1
Specifications .....	8-2
Material Safety Data Sheets .....	8-3

## Table of Figures

Figure 3-1 Desiccant wheel .....	3-1
Figure 3-2 How It Works .....	3-1
Figure 4-1 Setup.....	4-1
Figure 5-1 Controls .....	5-1
Figure 8-1 Electrical Schematic .....	8-1
Figure 8-2 Physical Dimensions .....	8-2

## Table of Tables

Table 2-1 Glycol/Water Mixture Chart.....	2-1
---	-----

# 1. Warranty Policies & Claim Procedures

DRYAIR MANUFACTURING CORP. (referred to within as DRYAIR) warrants its new, unused equipment to be free of defects in material and workmanship at the time of delivery to the original retail purchaser.

## Warranty Policies

### Basic Warranty Policy

- DRYAIR will repair or replace, at its option without charge, any defective part of the equipment for a period of twelve (12) months from delivery to the first retail purchaser, F.O.B St. Brieux, SK., Canada.
- Any parts that are covered by an extended warranty published by DRYAIR are an exception to the Basic Warranty Policy and are to be warrantied as per the details of the Extended Warranty Policy.
- Labour is covered as per DRYAIR flat labour rate.
- The Warranty Policy, terms and conditions, may change from time to time without prior notice.
- Warranty terms and conditions are transferable in the event of the sale to a second owner.
- Replacement parts will be warrantied for 90 days from the repair date. Bill of sale must accompany the warranty claim.
- The terms of this Warranty Policy are subject to provincial and state legislation. DRYAIR reserves the right to make modifications in accordance with provincial and state legislation without prior notice or obligation.

### Extended Warranty Policy

- An extended warranty is available on the heat exchanger unit of the water heater assembly. The available warranty for a part, under the Extended Warranty Policy, is prorated by 20% per year.
- Shipment date is the date to be used for the commencement of the warranty period.
- Coverage schedule
  - Year 1 - 100%
  - Year 2 - 80%
  - Year 3 - 60%
  - Year 4 - 40%
  - Year 5 - 20%

### Exceptions to the Warranty Policies

- Under no circumstance shall the owner be entitled to recover costs for incidental, special or consequential damages such as, but not limited to: loss of profit or revenue, other commercial losses, inconvenience and/or replacement equipment rental cost.
- Maintenance, repair or service items not related to warrantable defects
- Loss or damage during shipping
- Failure resulting from lack of or improper maintenance

- Damage caused by operator abuse, negligence or improper operation
- Damage resulting from improper voltage supply
- Damage from improper installation (installation done by someone other than the manufacturer)
- Non-defective items replaced at the request of the customer
- Damage due to accidents
- Damage resulting from improper fuel supply (i.e. pressure or contamination)
- Damage resulting from cracked or broken lines occurring during transport
- Damage resulting from use of inadequate or improper fluids (i.e. glycol or oil)
- Mileage is not covered
- Glycol is considered a consumable and will not be covered under the warranty policy.
- Generators carry their own warranty coverage through their own manufacturer. Please refer generator issues to the OEM. Contact information may be found in the Service & Operator Manual under Optional Equipment.

### **Owner Obligations**

- It is the responsibility of the owner, at the owner's expense, to transport the equipment to the service facility of an authorized DRYAIR distributor/dealer or alternately to reimburse the distributor/dealer for any traveling expenses incurred in fulfilling this warranty.
- It is the responsibility of the owner to read, understand, and implement the maintenance, safety, and operational guidelines as laid out in the Operation and Maintenance Guide.
- All parts are to be tagged with a warranty claim number and shipped prepaid to DRYAIR within 30 days.

### **Manufacturer Obligations**

- DRYAIR reserves the right to continually improve the product's parts or specifications at any time without notice or obligation.



## Warranty Claim Procedure

- All warranty credits must be processed with the DRYAIR Warranty Claim Form.
- All warranty parts, unless otherwise specified, are to be returned to DRYAIR along with a completed Warranty Claim Form.

*Note: Prior to returning warranty parts, please call for an authorization number and shipping instructions from the Warranty Department in Canada.*

Location of Warranty Depot:

**DRYAIR Manufacturing Corp.**  
**400 Service Road, PO Box 126**  
**St. Brieux, SK, Canada**  
**S0K 3V0**  
**Ph. 1 (888) 750-1700**

- Each warranty claim should only refer to one Serial or Production Schedule numbered unit.
- Warranty parts are to be tagged with a warranty claim number.
- When claiming for warranty labour, the allowable warranty labour rate will be \$65.00/hour. The factory reserves the right to adjust the number of hours claimed where deemed necessary.
- The factory may at times specify allowable labour for certain warranty procedures.
- Mileage and travel time to and from the customer are not eligible for warranty credit.
- Freight charges for warranty parts are not eligible for warranty credit.
- Labour flat rates for component changes:
  - Electrical Components - 0.5hr
    - Relays
    - Switches
    - Thermostats
    - Breakers
  - Electric Motor Changes - 1hr
    - Hose Reel
  - Plumbing Components - 1hr
    - Flow Reverser
    - Flow Switch
    - Valves
  - Glycol Pump Changes - 2hrs

*Note: Other labour charges will be at the discretion of DRYAIR*

## 2. Safety Concerns

### General Safety Concerns

- Make certain that the operator reads and understands all the information in this manual.
- All unauthorized individuals must be kept away from the equipment when in operation.
- All guards must be in place when the equipment is in operation.
- Maintain instructional and safety decals. Replace damaged decals.

### Heating Appliance

*\*Caution! This unit is a heating appliance.\**

Hot Heat Transfer Fluid is supplied to the unit via circulation lines and heat is distributed by the fan motor.

### Heat Transfer Fluid

*\*Caution! At no time should automobile antifreeze be used in your DRYAIR system. The use of automobile antifreeze will void your DRYAIR warranty. Always use Propylene Glycol as the heat transfer fluid.\**

- DRYAIR pre-mixed Heat Transfer Fluid is made up of 50% “Dowfrost ® HTF” or “Boss Chill PG” and 50% water, by weight, to provide freeze protection down to -28°F (-33°C).
- The Glycol/Water Mixture Chart (Table 2-1) will provide you with more information on the proper mixture for your area.
- Soft water with a neutral pH level (#7) must be used.

Table 2-1 Glycol/Water Mixture Chart

Percent Propylene Glycol		Freezing Point	
By Mass	By Volume	°F	°C
0.0	0.0	32.0	0.0
10.0	9.6	26.1	-3.2
20.0	19.4	17.9	-7.8
30.0	29.4	6.7	-14.0
40.0	39.6	-8.1	-22.3
50.0	49.9	-28.9	-33.8
60.0	60.0	-54.9	-48.3

*\*CAUTION! Whenever coupling or uncoupling the quick-couplers, make sure that the isolation valves are closed and the pump is turned off. Failure to do so may result in injury caused by hot heat transfer fluid.\**

For MSDS information regarding Propylene Glycol please see Appendix – Heat Transfer Fluid Information.

### 3. Introduction

Congratulations on the purchase of your new DCAN 25. This machine was primarily designed as a dehumidification device which can remove close to 300 gallons of water per day; however, it can also be used as a temporary heat source, as well as a fan for air movement. The DCAN 25 makes use of a desiccant wheel (Figure 3-1), a DRYAIR heat coil, and two 2500 CFM fans (one for reactivation air and one for process air).

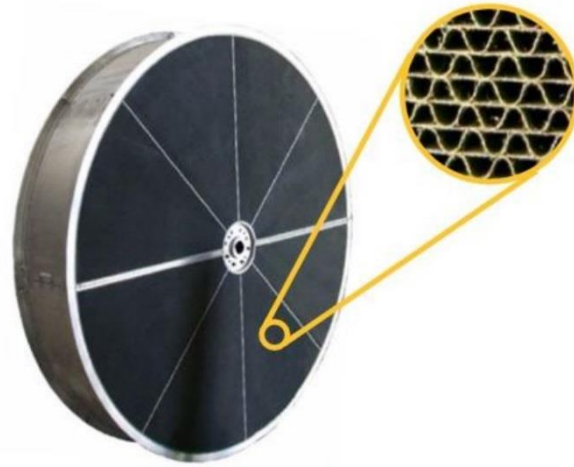

Figure 3-1 Desiccant wheel

The principle operation of desiccant dehumidifiers is very simple, in that moisture is absorbed onto a desiccant wheel as air passes through and the air leaves as dry air. A small heater reactivates the wheel in another airstream and drives off the moisture which has collected on the drying side of the dehumidifier. As all the moisture is removed as water vapour by the desiccant wheel, the dehumidifier can operate effectively even at very low temperatures and still maintain the desired humidity conditions (Figure 3-2).

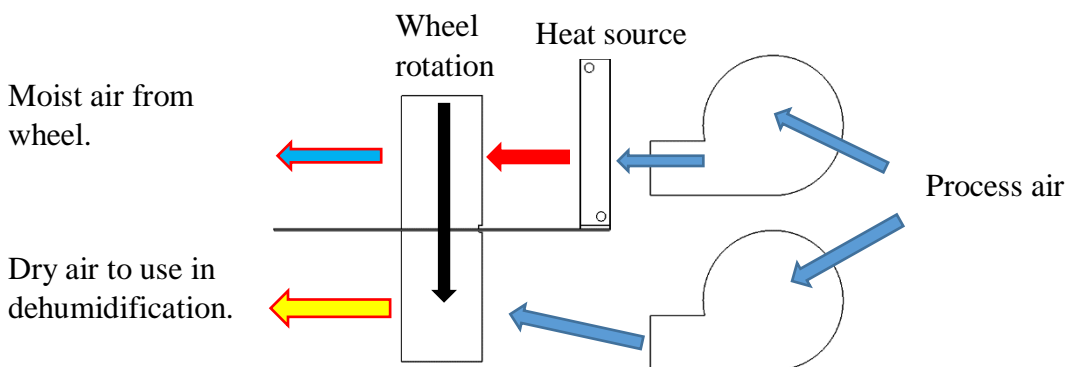

Figure 3-2 How It Works

Due to the use of hydronic heating to reactivate the desiccant wheel, there is no risk of combustible by-products to vent from the DCAN 25, and the risk of overheating is all but eliminated. This will also expand the fuel options to propane, natural gas, diesel or even steam.

## **Electrical Connections**

- The DCAN 25 uses two 2500 CFM fans, each fan requires an 115V/20A power source.
- A maximum of 100ft of 12 AWG (or equivalent) extension cord can be run to each unit.
- The electrical schematic for this unit can be found in Appendix – Electrical Schematic.

## **Fluid Connections**

- The DRYAIR heat coil uses 1in Camlock style quick couplers for fast connections with minimal glycol loss.

# 4. Setup

## Positioning

With the use of DRYAIR’s heat sources, and the low power requirements, there are numerous ways to configure this equipment.

1. Ideally the DCAN 25 would be placed outside of the building requiring dehumidification (Figure 4-1). Access to the filters for maintenance and air flow should be considered. The 18in ducting will be connected to the dry air outlet and piped into the building.

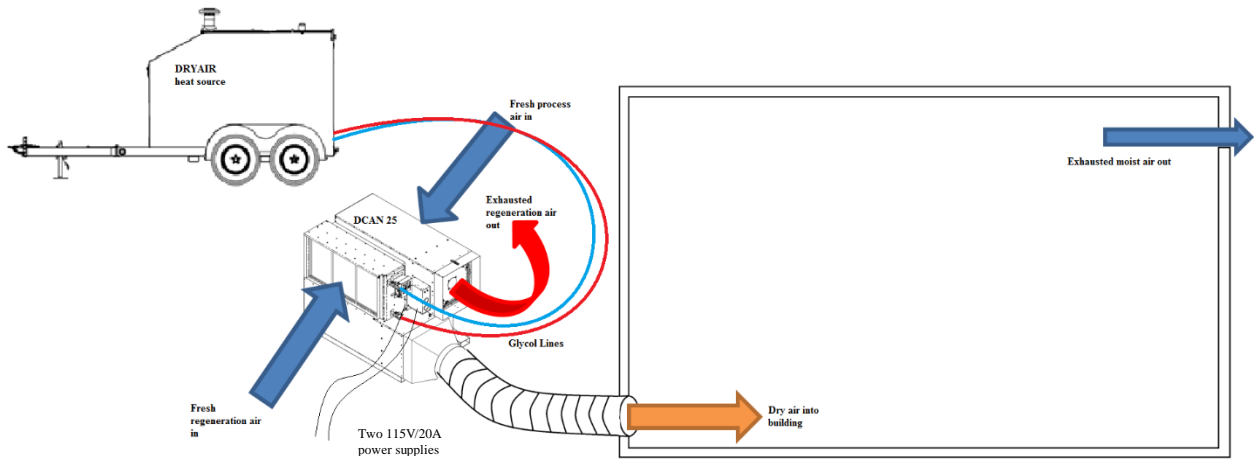

Figure 4-1 Setup

2. The DCAN 25 can be placed inside the building requiring dehumidification. Consideration needs to be made for the air intakes on both sides of the DCAN 25. The 18in ducting from the heated side of the wheel will need to be dumped outside to prevent reintroducing moisture to the dried air. Glycol lines from the heat source can be routed to the DCAN 25 via the 1in plumbing.

## 5. Operation

The controls (Figure 5-1) are all easily accessible. A simple ON / OFF switch for each fan (5-1a) are located on the front of the DCAN 25 on the control panel. They can run each fan independent from each other. The Glycol camlocks and shut off valves (5-1b) are also located in this area for easy monitoring and connections. The pressure gauges (5-1c) are to indicate filter changes and are also independent from each fan. As the pressure increases, less air is passed through indicating that the filters may need replacing. As an option, a remote humidistat (5-1d) can be added. The model shown has 50ft of cable to allow for remote monitoring and control. Place the remote on an interior wall away from direct contact with the process air stream.

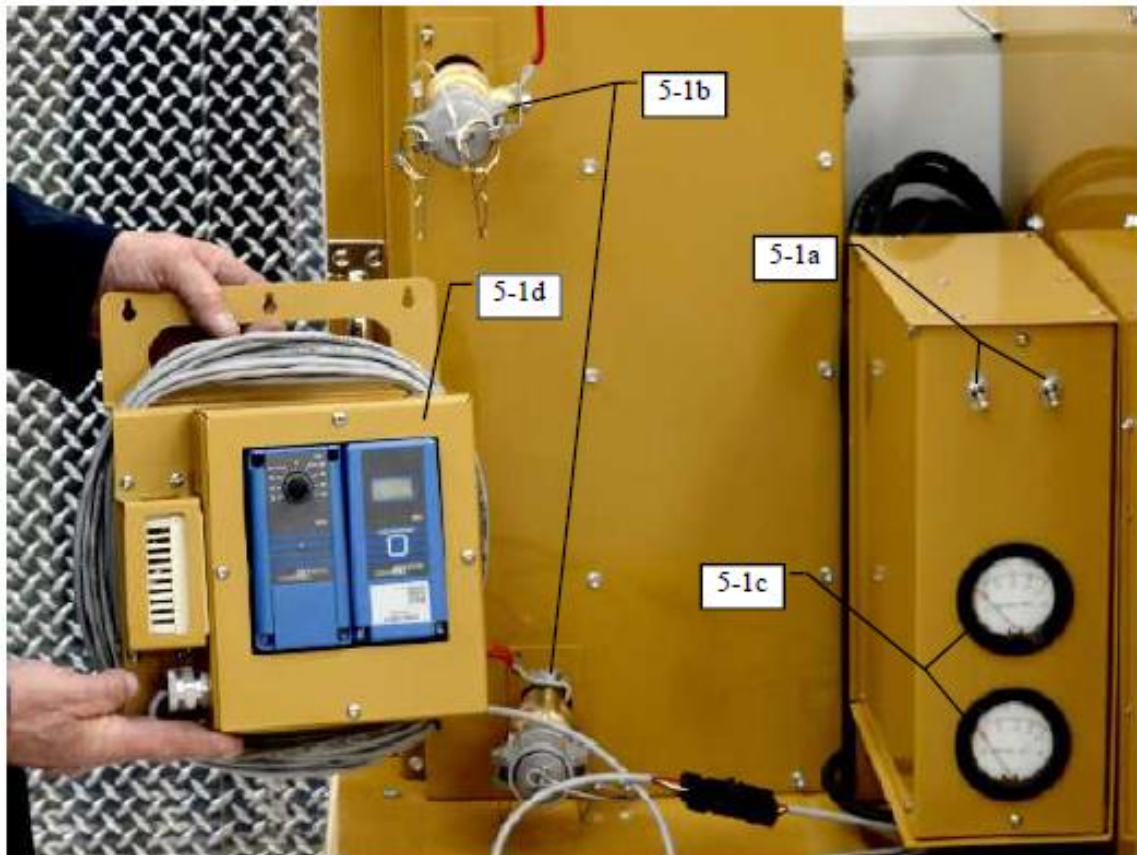

Figure 5-1 Controls

## 6. Troubleshooting

### Fan Does Not Start

#### No Power

- Check that power supply is connected to the unit.
- Check condition of the power connection cable (appliance cable).
- If Optional Remote Control is connected, check the setting of the humidistat (if the humidistat is set too high, the fan will not cut in).

### Fans Running and No Heat

#### Fluid Inlet is Cold

- Check that all quick couplers are open and fluid is circulating. If valves are closed, open valves to initiate flow. If valves are open and there is circulation however, the fluid is still cold, the problem is at the water heater. See the water heater operator's manual for full details.

#### Fluid Inlet is Hot, the Outlet is Cold and Still No Heat

- Check the unit coil for flow obstructions. If flow is obstructed, disconnect the module from the circulation system and flush.

### Heat Transfer Fluid is Leaking

- Check all connections, fittings and hoses. Tighten as required.
- Shut down the fan and check the coil for leaks. Replace the coil if leaks are found.

## 7. Maintenance

DRYAIR products are designed to be low maintenance systems. All assemblies are assembled using extensively tested and certified components. Following these maintenance procedures will ensure the maximum benefit and least amount of downtime for the system. The daily maintenance schedule is designed to be a quick system check and ensures a low risk of operating interruptions.

### Daily Checklist

#### Check the Heat Coil for Cleanliness or Clogging

- Clean as required (do not use high pressure air or water to clean the coil as this will cause damage to the coil fins).

#### Check all Fluid Fittings and Connections Daily

- Tighten or replace as required.

#### Check the Air Filter Daily if Applicable (Air Filter Not Supplied By DRYAIR)

- Replace if a paper filter is used.
- Wash if a foam washable filter is used.

### Storage

#### Hardware

- Exercise reasonable care when handling.
- The DCAN 25 should be sheltered when stored for extended periods of time.

#### Hose & Plastics

- To extend the life of the rubber and plastic components system (hoses and air tubes), it is recommended that they be stored out of the sun when not in use



# 8. Appendix

## Electrical Schematic

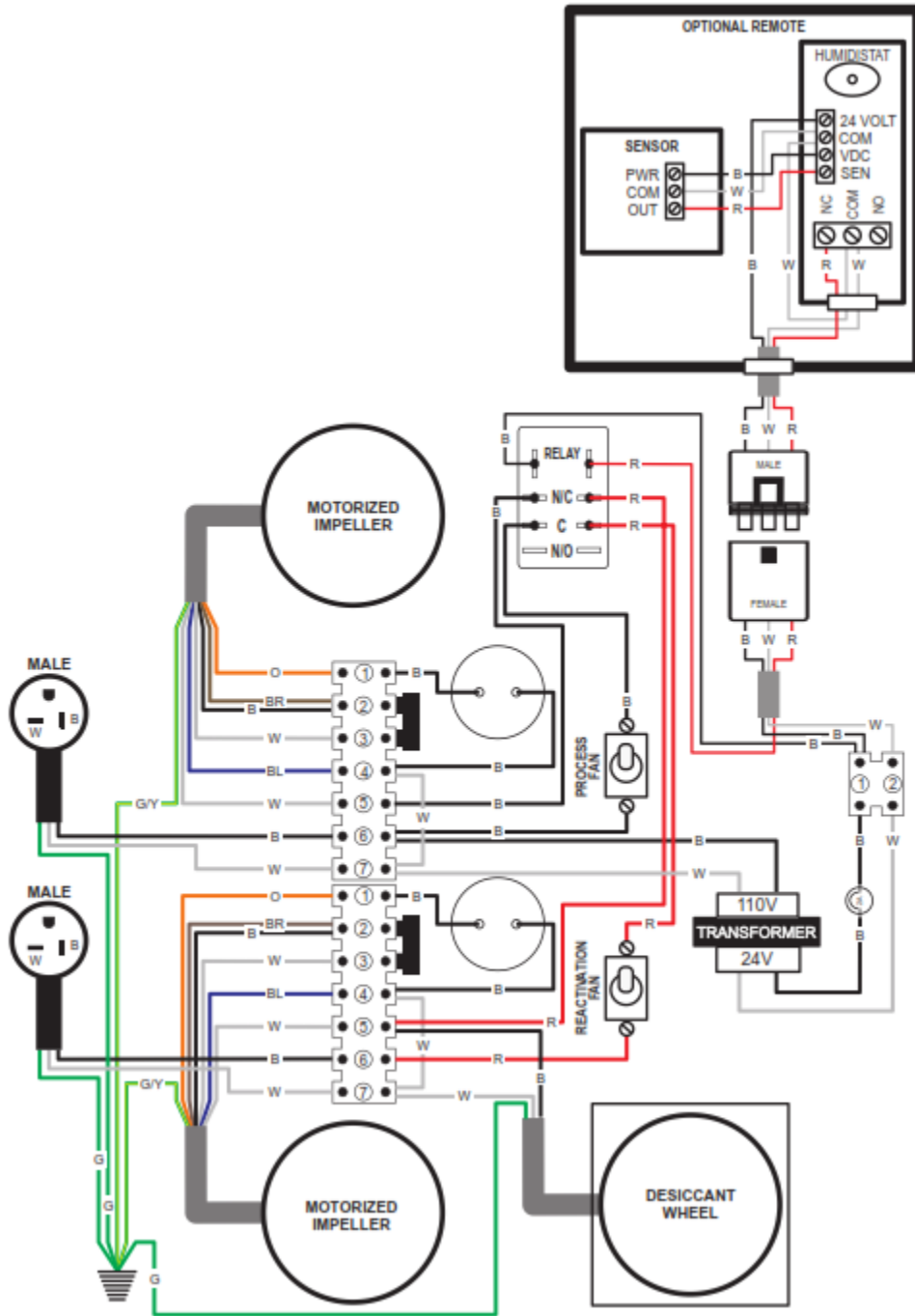
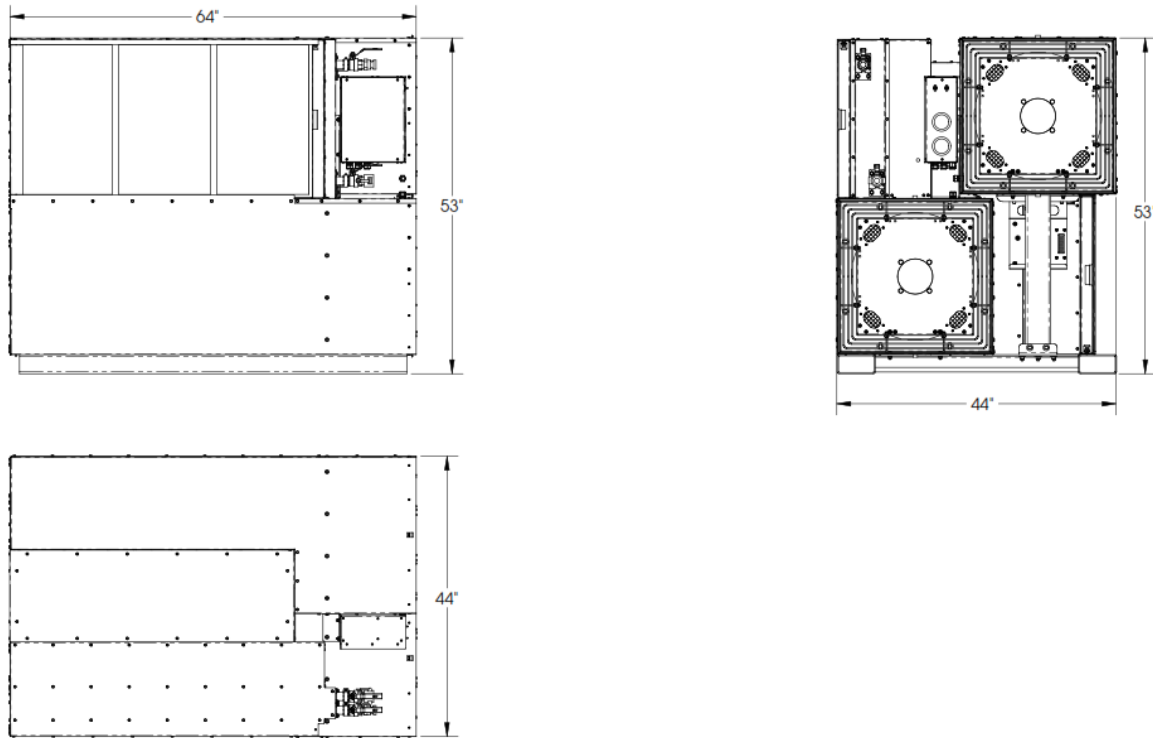

Figure 8-1 Electrical Schematic

## Specifications



*Figure 8-2 Physical Dimensions*

- Weight = 1080lbs
- Fans = 2500CFM / each
- Power requirements = Two 115VAC/20A



## **Material Safety Data Sheets**

The Material Safety Data Sheets (MSDS) included with this manual have been provided by DRYAIR's suppliers.



## MATERIAL SAFETY DATA SHEET

### SECTION 1: CHEMICAL PRODUCT AND COMPANY IDENTIFICATION

**PRODUCT NAME:** BOSS CHILL PROPYLENE GLYCOL  
 PROPYLENE-GLYCOL BASED  
 Heat Transfer Fluid Concentrate

**Date Prepared:** Sept 19, 2014

### COMPANY IDENTIFICATION

**Supplier:** BOSS LUBRICANTS  
 112, 6303 – 30 STREET SE  
 Calgary, AB T2C 1R4

**Telephone:** 403-279-2223

**Fax:** 403-279-2272

**Toll Free:** 800-844-9457

#### National Fire Protection Association

1	Health
1	Flammability
0	Reactivity
	Special



**Product Name:** BOSS CHILL PROPYLENE GLYCOL

**Product Description:** Propylene Glycol based industrial coolant and/or heat transfer fluid

**Chemical Name:** Inhibited propylene glycol, aqueous solution

**Chemical Family:** Mixture

**Formula:** Mixture

**Synonyms:** Heat transfer fluid, coolant

**DOT Identification:** Not regulated

**DOT Shipping No.:** Not regulated

**Manufacturer:** BOSS LUBRICANTS

### SECTION 2: TYPICAL COMPOSITION

<u>Material</u>	<u>CAS No</u>	<u>%Wt</u>
-----------------	---------------	------------





Propylene Glycol	000057-55-6	96%
Proprietary inhibitors	Not applicable	4%
Deionized Water	007732-18-5	Balance

This document is prepared pursuant to the OSHA Hazard Communication Standard (29 CFR 1910.122). In addition, other substances not "Hazardous" per this OSHA Standard may be listed. Where proprietary ingredients shows, the identity may be made available as provided in this standard.

**BOSS CHILL PROPYLENE GLYCOL  
BOSS LUBRICANTS: MATERIAL SAFETY DATA SHEET**

**SECTION 3: HAZARDOUS IDENTIFICATION**

**Health:** 2  
**Flammability:** 0  
**Reactivity:** 0  
**Special:** 0  
 0 = minimal 1 = slight 2 = moderate 3 = serious 4 = severe

HMIS
H # 2
F # 0
R # 0
PPE†
†Sec.8

**ROUTE(S) of Entry**

**Inhalation** A single prolonged (hours) inhalation exposure is not likely to cause adverse effects. Mists in high concentrations may cause irritation of nose and throat, cause headache, nausea or drowsiness. Prolonged or repeated exposure may result in the absorption of potentially harmful amounts of material.

**Skin:** A single prolonged exposure is not likely to result in the material being absorbed through skin in harmful amounts. Repeated exposure may cause slight flaking, tenderness and softening of skin.

**Ingestion:** Single dose oral toxicity is low. If more than several mouthfuls are swallowed, abdominal discomfort, nausea or diarrhea may occur

**Eyes:** May cause minor irritation of eyes in some individuals. Corneal injury is unlikely.

**Target Organs:** None known

**Effect of overexposure:** Repeated excessive ingestion may cause central nervous system effects. No carcinogenic effects have been seen in long-term animal studies. Birth defects are unlikely. Exposure having no adverse effects on the mother should have no effect





on the fetus. In animal studies, it has been shown not to interfere with reproduction. Results of mutagenicity tests in-vitro (test tube) and in animals have been negative.

**Signs and Symptoms of Exposure:**

Redness and/or stinging sensation in eyes or on skin. Minor eye or skin irritation may occur with some people.

**Medical conditions Generally Aggravated by**

**Long-Term Exposure:**

**Chronic Effects:** None known.

**Carcinogenicity**

**NTP:** None known

**IARC Monographs:** None known

**OSHA regulations:** None known

**ACGIH** None known

**SECTION 4: FIRST AID MEASURES**

**Emergency and First Aid Procedures**

**Eye Contact:** Flush eyes with large amounts of water for 15 minutes. If irritation persists, get medical attention.

**Skin Contact:** Wash off in flowing water or shower. Wash contaminated clothing before reuse.

**Ingestion:** DO NOT induce vomiting immediately and GET IMMEDIATE MEDICAL ATTENTION.

Never give anything by mouth to an unconscious person.

**Inhalation:** Remove to fresh air. If breathing has stopped, start artificial respiration. Seek medical attention.

**Note to Physicians:** Treat symptomatically. No specific antidote. Supportive care. Treatment based on judgment of physician in response to reactions of the patient.

**Special Precautions/**

**Procedure.** None known

**SECTION 5: FIRE-FIGHTING MEASURES**

**NFPA**

**Flash Point:** None

**Flash Point Method:** Not applicable



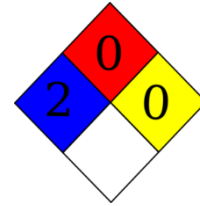

**Autoignition**

**Burning Rate:** Not available  
**Temperature:** Not available  
**Flammable limits in air (% by Volume)**  
**LEL:** Not available  
**UEL:** Not available

**Extinguishing Media:** Water for, fog, foam, CO2, dry chemical. Alcohol resistant foams (ATC type) are best when available. Do not use direct water stream as it may spread the fire.

**Unusual Fire or Explosion** Closed containers may rupture or explode due to steam pressure build-up when exposed to extreme heat.

**Hazards:** Water may be used to cool closed containers. Do not use a direct water stream on fire. Container may rupture from gas generation in a fire situation.

**Fire-Fighting Instructions:** Do not release runoff from fire control methods to sewers or waterways.

**Fire Fighting Equipment:** Full protective equipment including positive-pressure, self-contained breathing apparatus. During emergency conditions, overexposure to decomposition products may cause a health hazard. Symptoms may not be immediately apparent. Seek medical attention.

**Unusual Fire Fighting** Keep people out of the area and isolate fire. Burning liquids may be moved by flushing with water.

**Procedures:** Do not use a direct water stream as it may spread fire.

**SECTION 6: ACCIDENTAL RELEASE MEASURES**

**Spill/Leak Procedures:** Recover useable material by convenient method; residual may be removed by wipe or wet mop.

**Small Spills** Small spills should be absorbed with a suitable inert material (sand, earth, clay, etc.) Remove the absorbed material and place in an appropriate chemical waste container for disposal.

**Large Spills:** Large spills should be diked and pumped.

**Containment:** For large spills, dike far ahead of liquid spill for later disposal.

**Regulatory Requirements:** Follow applicable OSHA REGULATIONS (29 CFR 1910.120).



## SECTION 7: HANDLING AND STORAGE

**Handling Procedures:** Wear impermeable gloves and other protective clothing to avoid prolonged or repeated skin contact. When handling, wear eye protection.

**Storage Requirements:** Keep containers tightly closed when not in use. Store only in containers resistant to alkaline solutions with a pH of 9.0-12.0.

## SECTION 8: EXPOSURE CONTROLS/PERSONAL PROTECTION

**Exposure Guidelines:** Propylene Glycol: AIHA WEEL is 50 ppm total, 10mg/m<sup>3</sup> aerosol only. 10mg.m<sup>3</sup> for Propylene Glycol mist, 400ppm for Propylene Glycol vapors.

**Ventilation:** Provide general or local exhaust ventilation systems.

**Administrative Controls**

**Respiratory Protection:** If personal exposure cannot be controlled below applicable exposure limits by ventilation, wear respiratory devices approved by NIOSH/MSHA, for protection against organic vapors, dust, fumes and mists.

**Protective Clothing/ Equipment:** Wear chemically protective gloves, boots, aprons, and gauntlets to prevent prolonged or repeated skin contact. Wear protective eyeglasses or chemical safety goggles.

**Work and Hygienic Practices:** Wash or rinse hands before touching eyes or contact lenses, and before eating.

**Safety Stations:** Make emergency eyewash stations, safety/quick-drench showers, and washing facilities available in work area.

## SECTION 9: PHYSICAL AND CHEMICAL PROPETIES

**Appearance and odor:** dyed purple                      odor less

**Boiling point (760 mmHg):** 317°F 188°C

**Specific Gravity (water=1)** 1.040 - 1.060

**Solubility in Water (%by wt):** Complete

**pH:** 9.0 - 10.5

**Vapor Density) air=1):** <1.0

**Vapor Pressure:** 2.2mmHg

## SECTION 10: STABILITY AND REACTIVITY

**Stability:** Stable

**Polymerization:** Hazardous polymerization cannot occur

**Chemical Incompatibilities:** Oxidizing materials, strong acids

**Conditions to avoid:** Avoid contact with strong acids and strong oxidizers





**Hazardous decomposition Products:** Depends upon temperature, air supply and the presence of other materials

**SECTION 11: TOXICOLOGICAL INFORMATION**

**Eye Effects:** Irritating to eyes.  
**Skin Effects:** The LD50 for skin absorption in rabbits is >10,000 mg/kg.  
**Acute Inhalation Effects:** Significant vapors are only generated at elevated temperatures; may irritate nose and respiratory system.  
**Acute Oral Effects:** The oral LD50 for rats is 20,000-34,000 mg/kg.  
**Chronic Effects:** Liver and kidney damage in a 2 year rat feeding study using 1-2% Propylene Glycol  
Oral administration of very high doses of Propylene Glycol produced birth defects in laboratory animals.  
**Carcinogenicity:** None known  
**Mutagenicity:** Not mutagenic  
**Teratogenicity:** Not Teratogenic

**SECTION 12: ECOLOGICAL INFORMATION**

**Ecotoxicity:** Base primarily on data for the major components, product is practically non-toxic to aquatic organisms.  
**Irritation Index/Estimation of Irritation (Species):** Not determined.  
**Environmental Fate:** Decomposes to carbon, oxygen, nitrogen and water.  
**Environmental Degradation:** Biodegradable  
**Soil Absorption/Mobility:** Not determined

**SECTION 13: DISPOSAL CONSIDERATIONS**

**Waste disposal method;** Sanitary landfill or incinerate in approved facilities in accordance with local, state and federal regulations. Do not dump into any sewers, on the ground or into any body of water.  
**Disposal Regulatory** This product, if unused, does not meet the RCRA criteria for being identified as a hazardous waste by characteristics.  
**Requirements:**  
**Container Cleaning and Disposal:** Containers should be cleaned or residual product before disposal, and disposed of in accordance with all applicable laws and regulations.

**SECTION 14: TRANSPORT INFORMATION**

**DOT Shipping Name:** Not regulated  
**Shipping Symbols:** Not applicable  
**Hazard Class:** Not applicable **DOT**  
**Identification No.:** Not regulated



**Packing Group:** Not applicable  
**Label:** Not applicable  
**Special Provisions (172.102):** Not applicable

**Packaging Authorizations**

a) **Exceptions:** Not applicable  
b) **Non-bulk Packaging:** Not applicable  
c) **Bulk Packaging:** Not applicable

**Quantity Limitations**

a) **Passenger, Aircraft, or Railcar:** Not applicable  
b) **Cargo Aircraft Only:** Not applicable

**Vessel Stowage Requirements**

a) **Vessel Stowage:** Not applicable  
b) **Other:** Not applicable

**SECTION 15: REGULATORY INFORMATION**

**Regulatory Information:** **Notice:** The information herein is presented in good faith and believed to be as accurate as the effective date shown above. However, no warranty, expressed or implied, is given. Regulatory requirements are subject to change and may differ from one location to another. It is the buyer's responsibility to ensure that its activities comply with federal, state or provincial and local laws. The following specific information is made for the purpose of complying with numerous federal, state or provincial, and local laws and regulations

(Not meant to be all-inclusive -selected regulations represented.)

**EPA Regulations**

RCRA Hazardous Waste Number and RCRA  
Hazardous Waste Classification: Not applicable  
CERCLA Hazardous Substance and CERCLA Reportable Quantity: Not applicable

SARA313: To the best of our knowledge this product contains no chemical subject to SARA TITLE 111 Section 313 supplier notification requirements

SARA Hazard Category: This product has been reviewed according to the EPA "Hazard Categories promulgated under Section 311 and 312 of the Superfund Amendment and



Re-Authorization Act of 1986 (SARA Title III) and is considered, under applicable definitions not to have met any hazard category.

**OSHA regulations:**

This product is not a “Hazardous Chemical” as defined by the OSHA Hazard Communication Standard, 29 CFR 1910.1200

**WHMIS:**

(The Canadian Workplace Materials Information System)

Not a “Controlled Product” under WHMIS

Subdivision B (A toxic material causing other chronic effects) Hazardous

**SECTION 16 OTHER INFORMATION**

**Additional Hazard Rating Systems:** None

**Disclaimer: THE INFORMATION GIVEN HEREIN IS GIVEN IN GOOD FAITH AND FROM SOURCES WE BELIEVE RELIABLE. BUT NO WARRANTY, EXPRESS OR IMPLIED, REGARDING ITS CORRECTNESS IS MADE.**

The conditions or methods of handling, storage, use and disposal of this product are beyond our control and may be beyond our knowledge. For this and other reasons, we do not assume responsibility and expressly disclaim liability for loss, damage or expense arising out of or in any way connected with the handling, storage, use or disposal of this product.

This MSDS was prepared and is to be used only for this product. If the product is used as a component in another product, this MSDS information may not apply.

**CONSULT COMPANY LISTED IN SECTION 1 FOR FURTHER INFORMATION.**



# Material Safety Data Sheet

## DOW CHEMICAL CANADA ULC

Product name: DOWFROST™ Heat Transfer Fluid

Issue Date: 01/23/2015

Print Date: 06/29/2015

DOW CHEMICAL CANADA ULC encourages and expects you to read and understand the entire (M)SDS, as there is important information throughout the document. We expect you to follow the precautions identified in this document unless your use conditions would necessitate other appropriate methods or actions.

---

## 1. PRODUCT AND COMPANY IDENTIFICATION

---

Product name: DOWFROST™ Heat Transfer Fluid

### Recommended use of the chemical and restrictions on use

**Identified uses:** Intended as a heat transfer fluid for closed-loop systems. This product is acceptable for use where there is possibility of incidental food contact and as a product for use in the immersion or spray freezing of wrapped meat and packaged poultry products. We recommend that you use this product in a manner consistent with the listed use. If your intended use is not consistent with the stated use, please contact your sales or technical service representative.

### COMPANY IDENTIFICATION

DOW CHEMICAL CANADA ULC  
SUITE 2100  
450 - 1<sup>ST</sup> STREET S.W.  
CALGARY AB T2P 5H1  
CANADA

**For MSDS Updates and Product Information:** 800-258-2436

**Prepared by:** Prepared for use in Canada by EH&S, Hazard Communications.

**Revision Date:** 01/23/2015

**Print Date:** 06/29/2015

**Customer Information Number:**

800-258-2436

[SDSQuestion@dow.com](mailto:SDSQuestion@dow.com)

### EMERGENCY TELEPHONE NUMBER

**24-Hour Emergency Contact:** 989-636-4400

**Local Emergency Contact:** 613-996-6666

---

## 2. HAZARDS IDENTIFICATION

---

### Emergency Overview

#### Appearance

Physical state                      Liquid.

Color                                      Colorless

**Odor**                                      Characteristic

**Hazard Summary**

No significant immediate hazards for emergency response are known.

**Potential Health Effects**

**Eyes:** May cause slight temporary eye irritation.  
Corneal injury is unlikely.

**Skin:** Prolonged contact is essentially nonirritating to skin.  
Repeated contact may cause flaking and softening of skin.  
Prolonged skin contact is unlikely to result in absorption of harmful amounts.

**Inhalation:** At room temperature, exposure to vapor is minimal due to low volatility.  
Mist may cause irritation of upper respiratory tract (nose and throat).

**Ingestion:** Very low toxicity if swallowed.  
Harmful effects not anticipated from swallowing small amounts.

**Chronic Exposure:** In rare cases, repeated excessive exposure to propylene glycol may cause central nervous system effects.

---

**3. COMPOSITION/INFORMATION ON INGREDIENTS**

---

**Chemical nature:** Glycol  
This product is a mixture.

Component	CASRN	Weight percent
Propylene glycol	57-55-6	> 95.0 %
Dipotassium hydrogen phosphate	7758-11-4	< 3.0 %
Water	7732-18-5	< 3.0 %

---

**4. FIRST AID MEASURES**

---

**Description of first aid measures**

**General advice:** If potential for exposure exists refer to Section 8 for specific personal protective equipment.

**Inhalation:** Move person to fresh air; if effects occur, consult a physician.

**Skin contact:** Wash off with plenty of water.

**Eye contact:** Flush eyes thoroughly with water for several minutes. Remove contact lenses after the initial 1-2 minutes and continue flushing for several additional minutes. If effects occur, consult a physician, preferably an ophthalmologist.

**Ingestion:** No emergency medical treatment necessary.

**Most important symptoms and effects, both acute and delayed:** Aside from the information found under Description of first aid measures (above) and Indication of immediate medical attention and special treatment needed (below), any additional important symptoms and effects are described in Section 11: Toxicology Information.

**Indication of any immediate medical attention and special treatment needed**

**Notes to physician:** No specific antidote. Treatment of exposure should be directed at the control of symptoms and the clinical condition of the patient.

---

## 5. FIREFIGHTING MEASURES

---

**Suitable extinguishing media:** Water fog or fine spray. Dry chemical fire extinguishers. Carbon dioxide fire extinguishers. Foam. Alcohol resistant foams (ATC type) are preferred. General purpose synthetic foams (including AFFF) or protein foams may function, but will be less effective.

**Unsuitable extinguishing media:** Do not use direct water stream. May spread fire.

**Special hazards arising from the substance or mixture**

**Hazardous combustion products:** During a fire, smoke may contain the original material in addition to combustion products of varying composition which may be toxic and/or irritating. Combustion products may include and are not limited to: Carbon monoxide. Carbon dioxide.

**Unusual Fire and Explosion Hazards:** Container may rupture from gas generation in a fire situation. Violent steam generation or eruption may occur upon application of direct water stream to hot liquids.

**Advice for firefighters**

**Fire Fighting Procedures:** Keep people away. Isolate fire and deny unnecessary entry. Use water spray to cool fire exposed containers and fire affected zone until fire is out and danger of reignition has passed. Fight fire from protected location or safe distance. Consider the use of unmanned hose holders or monitor nozzles. Immediately withdraw all personnel from the area in case of rising sound from venting safety device or discoloration of the container. Burning liquids may be extinguished by dilution with water. Do not use direct water stream. May spread fire. Move container from fire area if this is possible without hazard. Burning liquids may be moved by flushing with water to protect personnel and minimize property damage.

**Special protective equipment for firefighters:** Wear positive-pressure self-contained breathing apparatus (SCBA) and protective fire fighting clothing (includes fire fighting helmet, coat, trousers, boots, and gloves). If protective equipment is not available or not used, fight fire from a protected location or safe distance.

---

## 6. ACCIDENTAL RELEASE MEASURES

---

**Personal precautions, protective equipment and emergency procedures:** Use appropriate safety equipment. For additional information, refer to Section 8, Exposure Controls and Personal Protection.

**Environmental precautions:** Prevent from entering into soil, ditches, sewers, waterways and/or groundwater. See Section 12, Ecological Information.

**Methods and materials for containment and cleaning up:** Small spills: Absorb with materials such as: Cat litter. Sawdust. Vermiculite. Zorb-all®. Collect in suitable and properly labeled containers. Large spills: Dike area to contain spill. Recover spilled material if possible. See Section 13, Disposal Considerations, for additional information.

---

## 7. HANDLING AND STORAGE

---

**Precautions for safe handling:** No special precautions required. Keep container closed. See Section 8, EXPOSURE CONTROLS AND PERSONAL PROTECTION.

Spills of these organic materials on hot fibrous insulations may lead to lowering of the autoignition temperatures possibly resulting in spontaneous combustion.

**Conditions for safe storage:** Do not store in: Galvanized steel. Opened or unlabeled containers. Store in original unopened container. See Section 10 for more specific information. Additional storage and handling information on this product may be obtained by calling your sales or customer service contact.

---

## 8. EXPOSURE CONTROLS/PERSONAL PROTECTION

---

### Control parameters

Exposure limits are listed below, if they exist.

Component	Regulation	Type of listing	Value/Notation
Propylene glycol	US WEEL	TWA	10 mg/m <sup>3</sup>
	CA ON OEL	TWAEV Total	155 mg/m <sup>3</sup> 50 ppm
	CA ON OEL	TWAEV	10 mg/m <sup>3</sup>
	CA ON OEL	TWA	155 mg/m <sup>3</sup> 50 ppm
	CA ON OEL	TWA	10 mg/m <sup>3</sup>

Consult local authorities for recommended exposure limits.

### Exposure controls

**Engineering controls:** Use local exhaust ventilation, or other engineering controls to maintain airborne levels below exposure limit requirements or guidelines. If there are no applicable exposure limit requirements or guidelines, general ventilation should be sufficient for most operations. Local exhaust ventilation may be necessary for some operations.

### Individual protection measures

**Eye/face protection:** Use safety glasses (with side shields).

#### Skin protection

**Hand protection:** Use gloves chemically resistant to this material when prolonged or frequently repeated contact could occur. Examples of preferred glove barrier materials include: Butyl rubber. Natural rubber ("latex"). Neoprene. Nitrile/butadiene rubber ("nitrile" or "NBR"). Polyethylene. Ethyl vinyl alcohol laminate ("EVAL"). Polyvinyl alcohol ("PVA"). Polyvinyl chloride ("PVC" or "vinyl"). NOTICE: The selection of a specific glove for a particular application and duration of use in a workplace should also take into account all relevant workplace factors such as, but not limited to: Other chemicals which may be handled, physical requirements (cut/puncture protection, dexterity, thermal protection), potential body reactions to glove materials, as well as the instructions/specifications provided by the glove supplier.

**Other protection:** Wear clean, body-covering clothing.

**Respiratory protection:** Respiratory protection should be worn when there is a potential to exceed the exposure limit requirements or guidelines. If there are no applicable exposure limit requirements or guidelines, wear respiratory protection when adverse effects, such as respiratory irritation or discomfort have been experienced, or where indicated by your risk assessment process. In misty atmospheres, use an approved particulate respirator. The following should be effective types of air-purifying respirators: Organic vapor cartridge with a particulate pre-filter.

---

## 9. PHYSICAL AND CHEMICAL PROPERTIES

---

### Appearance

Physical state	Liquid.
Color	Colorless
Odor	Characteristic
Odor Threshold	No test data available
pH	10.0 50% <i>Literature</i>
Melting point/range	Not applicable to liquids
Freezing point	supercools
Boiling point (760 mmHg)	152 °C <i>Literature</i>
Flash point	<b>closed cup</b> 104 °C <i>Pensky-Martens Closed Cup ASTM D 93</i> (based on major component), Propylene glycol. <b>open cup</b> <i>Cleveland Open Cup ASTM D92</i> None
Evaporation Rate (Butyl Acetate = 1)	<0.5 <i>Estimated.</i>
Flammability (solid, gas)	Not applicable to liquids
Lower explosion limit	2.6 % vol <i>Literature</i> Propylene glycol.
Upper explosion limit	12.5 % vol <i>Literature</i> Propylene glycol.
Vapor Pressure	2.2 mmHg <i>Literature</i>
Relative Vapor Density (air = 1)	>1.0 <i>Literature</i>
Relative Density (water = 1)	1.05 at 20 °C / 20 °C <i>Literature</i>
Water solubility	100 % <i>Literature</i>
Partition coefficient: n-octanol/water	no data available
Auto-ignition temperature	371 °C <i>Literature</i> Propylene glycol.
Decomposition temperature	No test data available
Kinematic Viscosity	43.4 cSt at 20 °C <i>Literature</i>
Explosive properties	no data available
Oxidizing properties	no data available
Molecular weight	76.9 g/mol <i>Literature</i>

NOTE: The physical data presented above are typical values and should not be construed as a specification.



---

---

## 10. STABILITY AND REACTIVITY

---

**Reactivity:** no data available

**Chemical stability:** Stable under recommended storage conditions. See Storage, Section 7.  
Hygroscopic

**Possibility of hazardous reactions:** Polymerization will not occur.

**Conditions to avoid:** Exposure to elevated temperatures can cause product to decompose. Generation of gas during decomposition can cause pressure in closed systems. Avoid direct sunlight or ultraviolet sources.

**Incompatible materials:** Avoid contact with: Strong acids. Strong bases. Strong oxidizers.

**Hazardous decomposition products:** Decomposition products depend upon temperature, air supply and the presence of other materials. Decomposition products can include and are not limited to: Aldehydes. Alcohols. Ethers. Organic acids.

---

---

## 11. TOXICOLOGICAL INFORMATION

---

*Toxicological information on this product or its components appear in this section when such data is available.*

### Acute toxicity

#### Acute oral toxicity

Very low toxicity if swallowed. Harmful effects not anticipated from swallowing small amounts.

For the major component(s): Propylene glycol.  
LD50, Rat, > 20,000 mg/kg

#### Acute dermal toxicity

Prolonged skin contact is unlikely to result in absorption of harmful amounts.

For the major component(s): Propylene glycol.  
LD50, Rabbit, > 20,000 mg/kg

#### Acute inhalation toxicity

At room temperature, exposure to vapor is minimal due to low volatility. Mist may cause irritation of upper respiratory tract (nose and throat).

For the major component(s):  
LC50, Rat, 4 Hour, vapour, 6.15 mg/l No deaths occurred following exposure to a saturated atmosphere.

### Skin corrosion/irritation

Prolonged contact is essentially nonirritating to skin.  
Repeated contact may cause flaking and softening of skin.

**Serious eye damage/eye irritation**

May cause slight temporary eye irritation.  
Corneal injury is unlikely.

**Sensitization**

For the major component(s):  
Did not cause allergic skin reactions when tested in humans.

For respiratory sensitization:  
No relevant data found.

**Specific Target Organ Systemic Toxicity (Single Exposure)**

Evaluation of available data suggests that this material is not an STOT-SE toxicant.

**Specific Target Organ Systemic Toxicity (Repeated Exposure)**

In rare cases, repeated excessive exposure to propylene glycol may cause central nervous system effects.

**Carcinogenicity**

Similar formulations did not cause cancer in laboratory animals.

**Teratogenicity**

For the major component(s): Did not cause birth defects or any other fetal effects in laboratory animals.

**Reproductive toxicity**

For the major component(s): In animal studies, did not interfere with reproduction. In animal studies, did not interfere with fertility.

**Mutagenicity**

In vitro genetic toxicity studies were negative. For the major component(s): Animal genetic toxicity studies were negative.

**Aspiration Hazard**

Based on physical properties, not likely to be an aspiration hazard.

---

---

**12. ECOLOGICAL INFORMATION**

---

*Ecotoxicological information on this product or its components appear in this section when such data is available.*

**Toxicity**

**Propylene glycol**

**Acute toxicity to fish**

Material is practically non-toxic to aquatic organisms on an acute basis (LC50/EC50/EL50/LL50 >100 mg/L in the most sensitive species tested).  
LC50, *Oncorhynchus mykiss* (rainbow trout), static test, 96 Hour, 40,613 mg/l, OECD Test Guideline 203

**Acute toxicity to aquatic invertebrates**

LC50, Ceriodaphnia dubia (water flea), static test, 48 Hour, 18,340 mg/l, OECD Test Guideline 202

**Acute toxicity to algae/aquatic plants**

ErC50, Pseudokirchneriella subcapitata (green algae), 96 Hour, Growth rate inhibition, 19,000 mg/l, OECD Test Guideline 201

**Toxicity to bacteria**

NOEC, Pseudomonas putida, 18 Hour, > 20,000 mg/l

**Chronic toxicity to aquatic invertebrates**

NOEC, Ceriodaphnia dubia (water flea), semi-static test, 7 d, number of offspring, 13,020 mg/l

**Dipotassium hydrogen phosphate**

**Acute toxicity to fish**

Material is practically non-toxic to aquatic organisms on an acute basis (LC50/EC50/EL50/LL50 >100 mg/L in the most sensitive species tested).

LC50, Leuciscus idus (Golden orfe), static test, 48 Hour, > 900 mg/l, Method Not Specified.

**Persistence and degradability**

**Propylene glycol**

**Biodegradability:** Material is readily biodegradable. Passes OECD test(s) for ready biodegradability. Biodegradation may occur under anaerobic conditions (in the absence of oxygen).

10-day Window: Pass

**Biodegradation:** 81 %

**Exposure time:** 28 d

**Method:** OECD Test Guideline 301F or Equivalent

10-day Window: Not applicable

**Biodegradation:** 96 %

**Exposure time:** 64 d

**Method:** OECD Test Guideline 306 or Equivalent

**Theoretical Oxygen Demand:** 1.68 mg/mg

**Chemical Oxygen Demand:** 1.53 mg/mg

**Biological oxygen demand (BOD)**

Incubation Time	BOD
5 d	69.000 %
10 d	70.000 %
20 d	86.000 %

**Photodegradation**

**Atmospheric half-life:** 10 Hour

**Method:** Estimated.

**Dipotassium hydrogen phosphate**

**Biodegradability:** Biodegradation is not applicable.

**Bioaccumulative potential**

**Propylene glycol**

**Bioaccumulation:** Bioconcentration potential is low (BCF < 100 or Log Pow < 3).

**Partition coefficient: n-octanol/water(log Pow):** -1.07 Measured

**Bioconcentration factor (BCF):** 0.09 Estimated.

**Dipotassium hydrogen phosphate**

**Bioaccumulation:** No bioconcentration is expected because of the relatively high water solubility.

**Mobility in soil**

**Propylene glycol**

Given its very low Henry's constant, volatilization from natural bodies of water or moist soil is not expected to be an important fate process.

Potential for mobility in soil is very high (Koc between 0 and 50).

**Partition coefficient(Koc):** < 1 Estimated.

**Dipotassium hydrogen phosphate**

No relevant data found.

---

---

### **13. DISPOSAL CONSIDERATIONS**

---

**Disposal methods:** DO NOT DUMP INTO ANY SEWERS, ON THE GROUND, OR INTO ANY BODY OF WATER. All disposal practices must be in compliance with all Federal, State/Provincial and local laws and regulations. Regulations may vary in different locations. Waste characterizations and compliance with applicable laws are the responsibility solely of the waste generator. AS YOUR SUPPLIER, WE HAVE NO CONTROL OVER THE MANAGEMENT PRACTICES OR MANUFACTURING PROCESSES OF PARTIES HANDLING OR USING THIS MATERIAL. THE INFORMATION PRESENTED HERE PERTAINS ONLY TO THE PRODUCT AS SHIPPED IN ITS INTENDED CONDITION AS DESCRIBED IN MSDS SECTION: Composition Information. FOR UNUSED & UNCONTAMINATED PRODUCT, the preferred options include sending to a licensed, permitted: Recycler. Reclaimer. Incinerator or other thermal destruction device.

---

---

### **14. TRANSPORT INFORMATION**

---

**TDG**

Not regulated for transport

**Classification for SEA transport (IMO-IMDG):**

**Transport in bulk  
according to Annex I or II  
of MARPOL 73/78 and the  
IBC or IGC Code**

Not regulated for transport  
Consult IMO regulations before transporting ocean bulk

**Classification for AIR transport (IATA/ICAO):**

Not regulated for transport

This information is not intended to convey all specific regulatory or operational requirements/information relating to this product. Transportation classifications may vary by container volume and may be influenced by regional or country variations in regulations. Additional transportation system information can be obtained through an authorized sales or customer service representative. It is the responsibility of the transporting organization to follow all applicable laws, regulations and rules relating to the transportation of the material.

---

## 15. REGULATORY INFORMATION

---

### Hazardous Products Act Information: CPR Compliance

This product has been classified in accordance with the hazard criteria of the Canadian Controlled Products Regulations (CPR) and the MSDS contains all the information required by the CPR.

### Hazardous Products Act Information: WHMIS Classification

This product is not a "Controlled Product" under WHMIS.

### Canadian Domestic Substances List (DSL) (DSL)

All substances contained in this product are listed on the Canadian Domestic Substances List (DSL) or are not required to be listed.

---

## 16. OTHER INFORMATION

---

### Hazard Rating System

#### NFPA

Health	Fire	Reactivity
0	1	0

### Revision

Identification Number: 101234106 / A208 / Issue Date: 01/23/2015 / Version: 6.0

Most recent revision(s) are noted by the bold, double bars in left-hand margin throughout this document.

### Legend

CA ON OEL	Canada. Ontario OELs
TWA	8-hr TWA
TWAEV	time-weighted average exposure value
US WEEL	USA. Workplace Environmental Exposure Levels (WEEL)

### Information Source and References

This SDS is prepared by Product Regulatory Services and Hazard Communications Groups from information supplied by internal references within our company.

DOW CHEMICAL CANADA ULC urges each customer or recipient of this (M)SDS to study it carefully and consult appropriate expertise, as necessary or appropriate, to become aware of and understand

the data contained in this (M)SDS and any hazards associated with the product. The information herein is provided in good faith and believed to be accurate as of the effective date shown above. However, no warranty, express or implied, is given. Regulatory requirements are subject to change and may differ between various locations. It is the buyer's/user's responsibility to ensure that his activities comply with all federal, state, provincial or local laws. The information presented here pertains only to the product as shipped. Since conditions for use of the product are not under the control of the manufacturer, it is the buyer's/user's duty to determine the conditions necessary for the safe use of this product. Due to the proliferation of sources for information such as manufacturer-specific (M)SDSs, we are not and cannot be responsible for (M)SDSs obtained from any source other than ourselves. If you have obtained an (M)SDS from another source or if you are not sure that the (M)SDS you have is current, please contact us for the most current version.